

CZ

MONTÁŽ A NABÍJENÍ INTEGROVANÉ BATERIE

Návod k montáži a nabíjení integrované baterie Darfon u kol Superior a Rock Machine.

1 KRABICE S INTEGROVANOU BATERIÍ DARFON



2 BALENÍ INTEGROVANÉ BATERIE DARFON

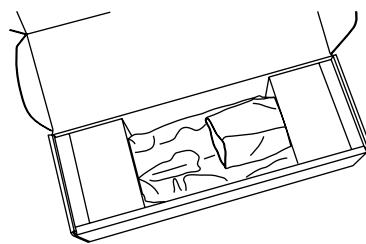

3 INTEGROVANÁ BATERIE DARFON

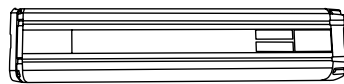

4 KRYT INTEGROVANÉ BATERIE

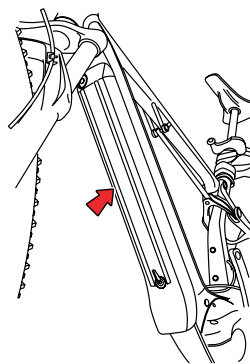

5 UZÁVĚR KRYTU DOKOVACÍ STANICE

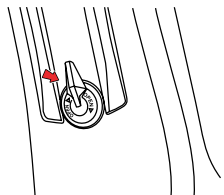

6 DEMONTÁŽ KRYTU DOKOVACÍ STANICE

6.1 Pro sejmutí krytu integrované baterie otočte ovladač uzávěru krytu dokovací stanice doprava po směru hodinových ručiček do polohy OPEN.
6.2 Vyjměte kryt z rámu.

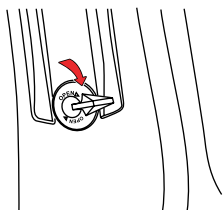

7 DOKOVACÍ STANICE PRO INTEGROVANOU BATERII PO DEMONTÁŽI KRYTU

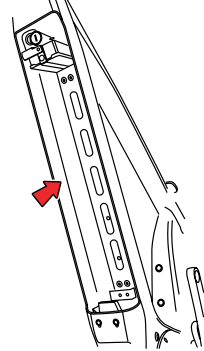

8 MONTÁŽ INTEGROVANÉ BATERIE

8.1 Vložte dolní část integrované baterie do dokovací stanice.

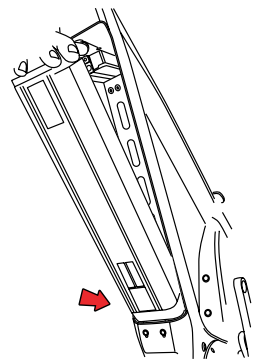

8.2 Zaklopte horní část integrované baterie na doraz do dokovací stanice, čímž dojde k zajištění pojistkou proti vysunutí.

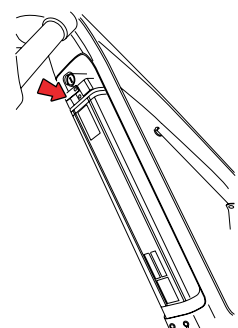

8.3 Uzavřete dokovací stanici krytem.

8.4 Zajištěte kryt otočením ovladače uzávěru proti směru hodinových ručiček.

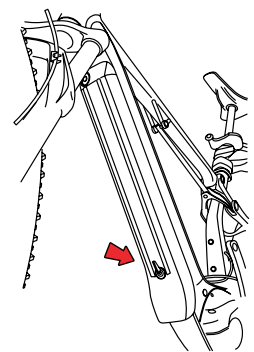

9 SPUŠTĚNÍ SYSTÉMU

9.1 Stiskněte a přidržte tlačítko na horní rámové trubce (1) nebo v horní části krytu baterie (2). Spuštění systému je signalizováno zvukovým signálem.

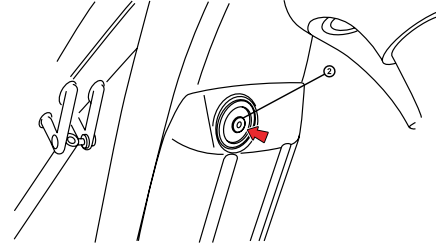
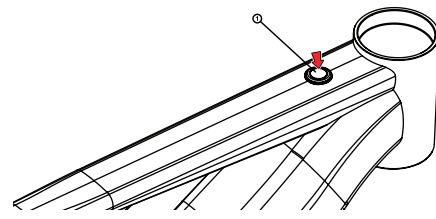

10 DEMONTÁŽ INTEGROVANÉ BATERIE

10.1 Zasuňte klíček do zámku pojistky a otočte jím proti směru hodinových ručiček, horní část baterie se částečně vysune z dokovací stanice

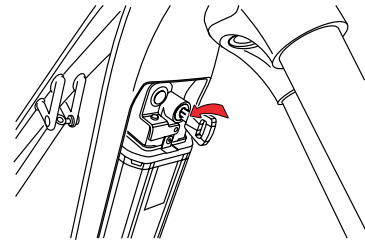

POZNÁMKA

Pokud se horní část baterie po otočení klíčku sama částečně nevysune, vysuňte ji ručně.

10.2 Stiskněte směrem dolů pružnou pojistku (1) a současně vysuňte horní část baterie z rámu.

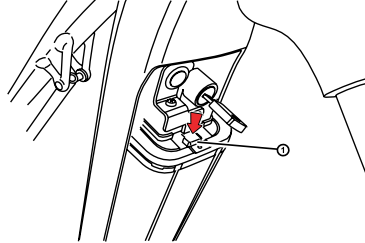

10.3 Baterie je uvolněna z dokovací stanice.

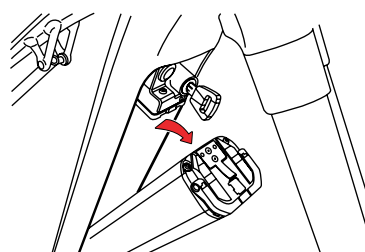

11 BALENÍ S NABÍJEČKOU

Nabíječka umožňuje samostatné nabíjení integrované baterie po její demontáži nebo přímo v dokovací stanici.

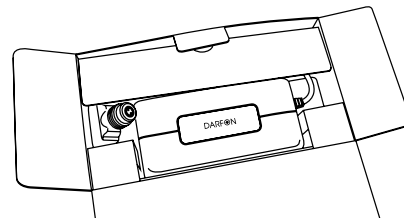

12 NABÍJENÍ INTEGROVANÉ BATERIE MIMO DOKOVACÍ STANICE

12.1 Spojte adaptér (1) s konektorem kabelu nabíječky (2).

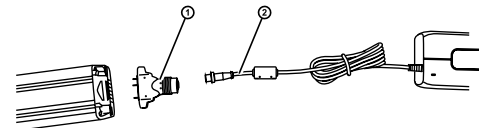

12.2 Zapojte nabíječku do elektrické sítě 220 V.

12.3 Připojte adaptér (1) k baterii (2).

12.4 Po ukončení nabíjení odpojte nabíječku z elektrické sítě 220 V.

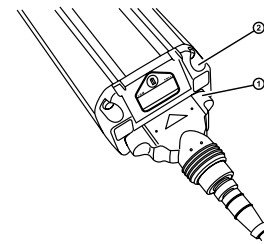

13 NABÍJENÍ INTEGROVANÉ BATERIE V DOKOVACÍ STANICI

13.1 Zásuvka pro nabíjení v dokovací stanici je uzavřena gumovou krytkou (1).

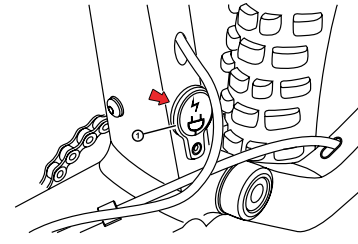

13.2 Otevřete zásuvku pro nabíjení (2) vysunutím gumové krytky (1).

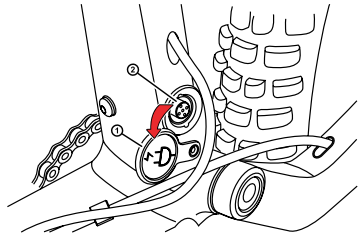

13.3 Zapojte nabíječku do elektrické sítě 220 V.
13.4 Zasuňte konektor kabelu nabíječky (3) ve správné poloze do zásuvky pro nabíjení (2).

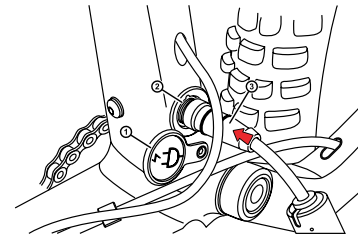

UPOZORNĚNÍ

Konektor kabelu nabíječky do zásuvky nešroubujte, mohlo by dojít k poškození kontaktů.

13.5 Po ukončení nabíjení odpojte nabíječku z elektrické sítě 220 V.

13.6 Vysuňte konektor kabelu nabíječky (3) ze zásuvky.

13.7 Uzavřete zásuvku pro nabíjení (2) zasunutím gumové krytky (1).



UPOZORNĚNÍ PRO PRODEJCE

Reklamované baterie zasílejte vždy v originálním balení. Proto doporučujeme originální balení vždy uchovat.

EN

INSTALLING AND CHARGING INTEGRATED BATTERY

Mounting and charging instructions for the Darfon integrated battery for Superior and Rock Machine bikes.

1 DARFON INTEGRATED BATTERY BOX

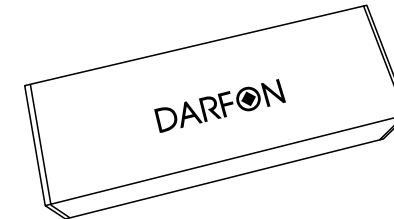

2 DARFON INTEGRATED BATTERY PACKAGING

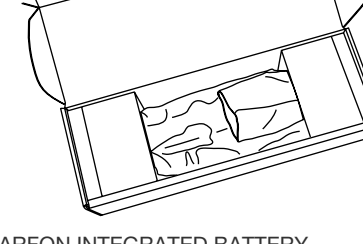

3 DARFON INTEGRATED BATTERY



4 INTEGRATED BATTERY COVER

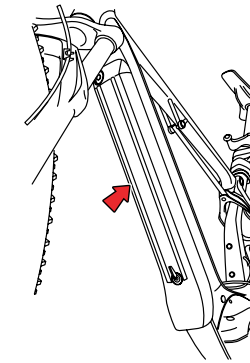

5 DOCKING STATION COVER LOCK

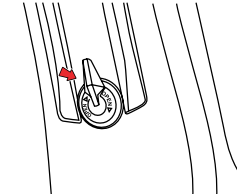

6 REMOVING THE DOCKING STATION COVER

6.1 To remove the integrated battery cover, turn the docking station cover lock knob clockwise to OPEN.

6.2 Remove the cover from the frame

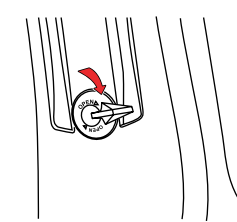

7 INTEGRATED BATTERY DOCKING STATION AFTER COVER REMOVAL

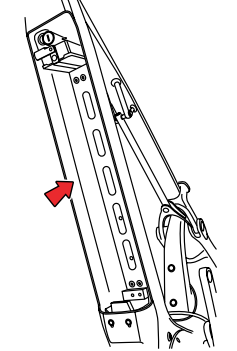

8 INSTALLING THE INTEGRATED BATTERY

8.1 Insert the bottom part of the integrated battery into the docking station

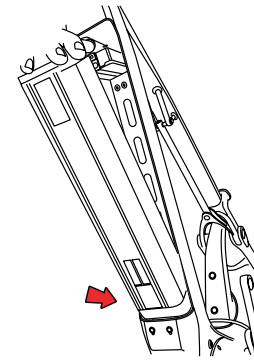

8.2 Tilt the top of the integrated battery into the docking station as far as it will go to lock it in place.

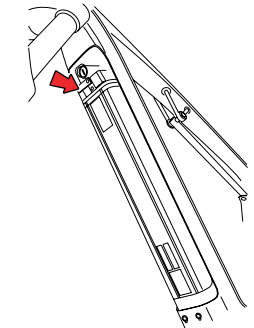

8.3 Close the docking station cover.

8.4 Secure the cover by turning the lock knob anticlockwise.

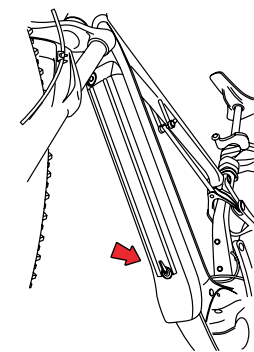

9 SYSTEM START-UP

9.1 Press and hold the button on top tube (1) or at the top of the battery cover (2). System start-up is indicated by an audible signal and the display lights up.

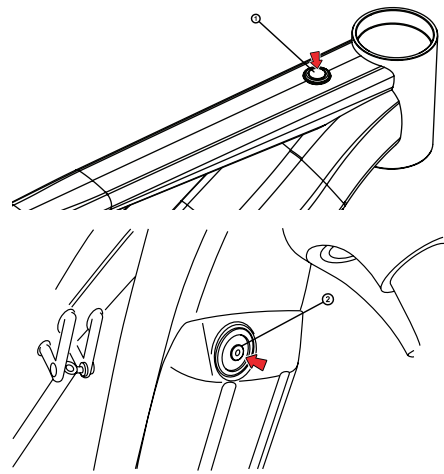

10 REMOVING THE INTEGRATED BATTERY

10.1 Insert the key into the safety lock and turn it anticlockwise to partially eject the top of the battery from the docking station.

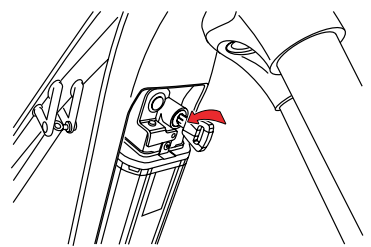

NOTE
If the top of the battery does not partially eject after turning the key, release it manually.

10.2 Press the spring catch down (1) and pull the top of the battery out of the frame at the same time.

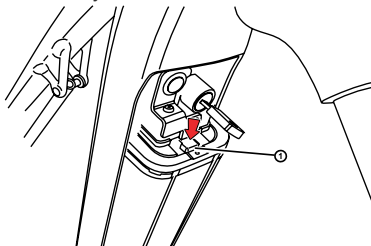

10.3 The battery is released from the docking station.

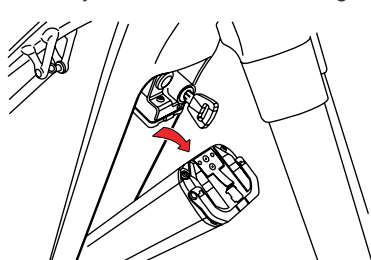

11 PACKAGE WITH CHARGER

The charger allows you to charge the integrated battery separately after it is removed or directly in the docking station.

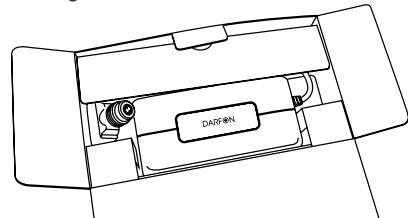

12 CHARGING THE INTEGRATED BATTERY OUTSIDE THE DOCKING STATION

12.1 Connect the adapter (1) to the charger cable connector (2).

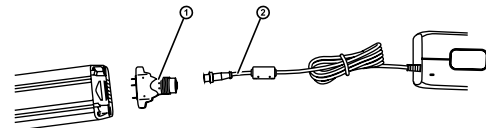

12.2 Connect the charger to the 220 V mains.

12.3 Connect the adapter (1) to the battery (2).

12.4 When charging is complete, disconnect the charger from the 220V mains.

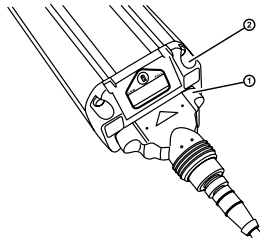

13 CHARGING THE INTEGRATED BATTERY IN THE DOCKING STATION

13.1 The docking station charging socket is closed with a rubber cap (1).

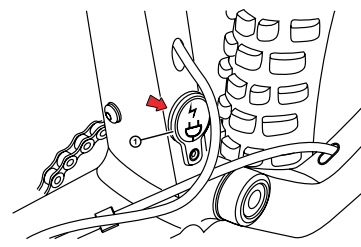

13.2 Open the charging socket (2) by releasing the rubber cap (1).

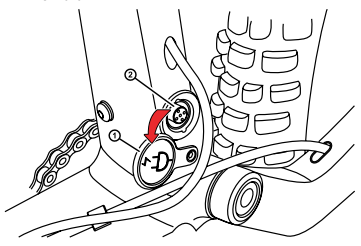

13.3 Connect the charger to the 220 V mains.

13.4 Plug the charger cable connector (3) into the charging socket (2) in the correct position.

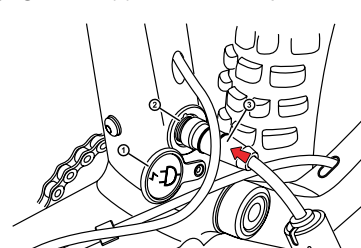

CAUTION
Do not screw the charger cable plug into a wall socket as this may damage the contacts.

13.5 Disconnect the charger from the 220 V mains after charging is complete.

13.6 Pull the charger cable connector (3) out of the socket.

13.7 Close the charging socket (2) by inserting the rubber cap (1).



NOTICE TO THE DEALER
Claimed batteries send always in the original packaging. Therefore, we always recommend to keep the original packaging.

DE MONTAGE UND LADUNG DER INTEGRIERTEN BATTERIE

Montage- und Ladungsanleitung der integrierten Batterie Darfon für die Fahrräder Superior und Rock Machine.

1 KARTON MIT DER INTEGRIERTEN BATTERIE



2 VERPACKUNG DER INTEGRIERTEN BATTERIE

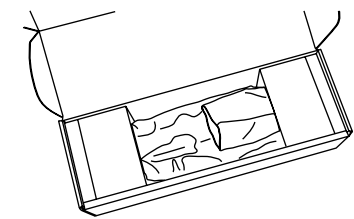

3 INTEGRIERTE BATTERIE DARFON

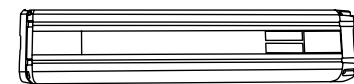

4 ABDECKUNG DER INTEGRIERTEN BATTERIE

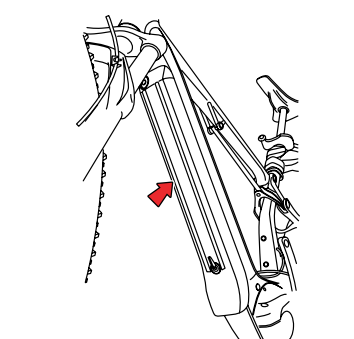

5 ABDECKUNGSVERSCHLUSS DER DOCKSTATION

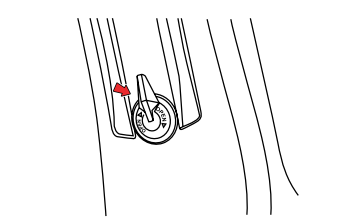

6 DEMONTAGE DER ABDECKUNG DER DOCKSTATION

6.1 Nach der Entnahme der Abdeckung der integrierten Batterie den Bedienungsknopf des Abdeckungsverschlusses der Dockstation nach rechts im Uhrzeigersinn in die Stellung OPEN drehen.

6.2 Abdeckung aus dem Rahmen entnehmen



7 DOCKSTATION FÜR DIE INTEGRIERTE BATTERIE NACH DER ENTNAHME DER ABDECKUNG

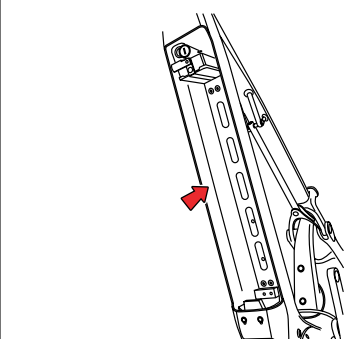

8 MONTAGE DER INTEGRIERTEN BATTERIE

8.1 Unteren Teil der integrierten Batterie in die Dockstation einlegen

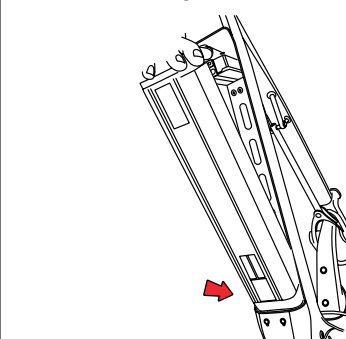

8.2 Oberen Teil der integrierten Batterie bis zum Anschlag in die Dockstation einklappen, wodurch die Verriegelung durch die Sicherung gegen Herausfahren erfolgt.

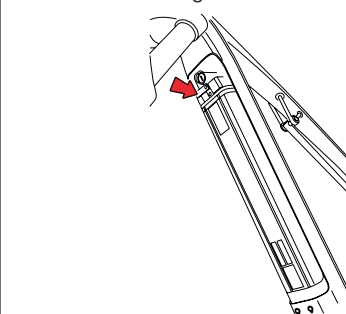

8.3 Dockstation mit Abdeckung schließen.

8.4 Abdeckung durch das Drehen des Bedienungsknopfs gegen Uhrzeigersinn sichern.

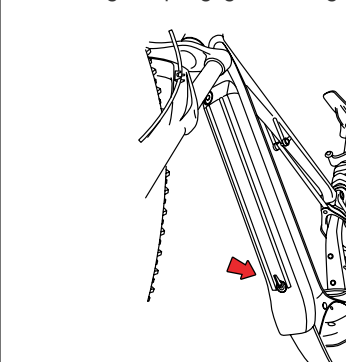

9 SYSTEMSTART

9.1 Halten Sie die Taste am Oberrohr (1) oder oben an der Batterieabdeckung (2) gedrückt. Der Systemstart wird durch ein akustisches Signal angezeigt und die Anzeige leuchtet auf.

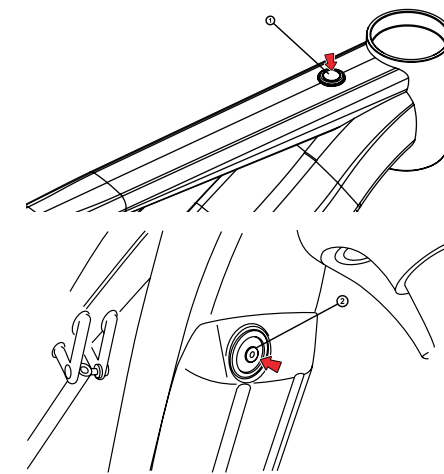

10 DEMONTAGE DER INTEGRIERTEN BATTERIE

10.1 Schlüssel in das Sicherungsschloss stecken und gegen den Uhrzeigersinn drehen, der obere Batterieteil fährt teilweise aus der Dockstation heraus.

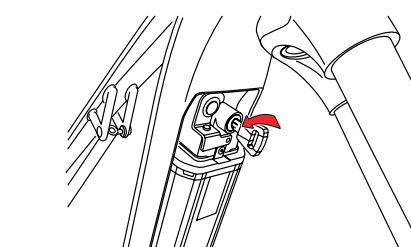

HINWEIS
Falls der obere Batterieteil nach dem Drehen des Schlüssels nicht selbst teilweise herausfährt, dann mit Hand herausziehen.

10.2 Federsicherung (1) nach unten drücken und gleichzeitig den oberen Batterieteil aus dem Rahmen herauschieben.

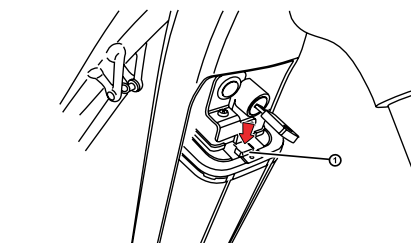

10.3 Die Batterie wird aus der Dockstation gelöst.

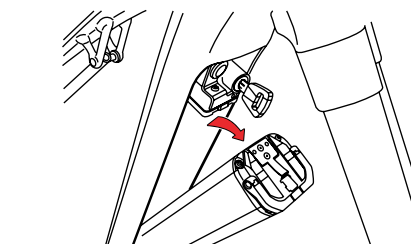

11 VERPACKUNG MIT LADEGERÄT

Das Ladegerät ermöglicht das selbständige Laden der integrierten Batterie nach deren Demontage oder direkt in der Dockstation.

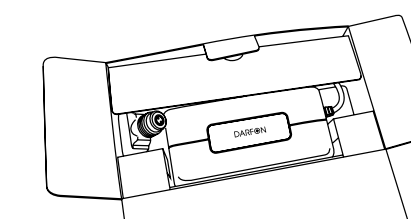

12 LADEN DER INTEGRIERTEN BATTERIE AUSSERHALB DER DOCKSTATION

12.1 Adapter (1) mit dem Verbindungsstecker des Ladegerätkabels (2) verbinden.

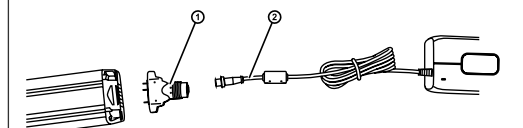

12.2 Ladegerät ans Stromnetz 220 V anschließen.

12.3 Adapter (1) an die Batterie anschließen (2).

12.4 Nach dem Laden das Ladegerät vom Stromnetz 220 V trennen.

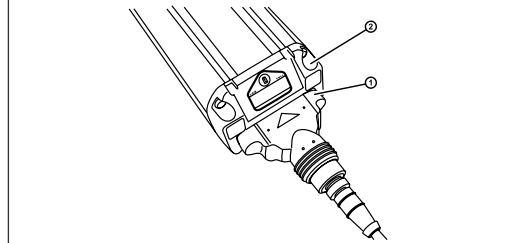

13 LADEN DER INTEGRIERTEN BATTERIE IN DER DOCKSTATION

13.1 Die Ladebuchse in der Dockstation ist mit der Gummikappe (1) geschlossen.

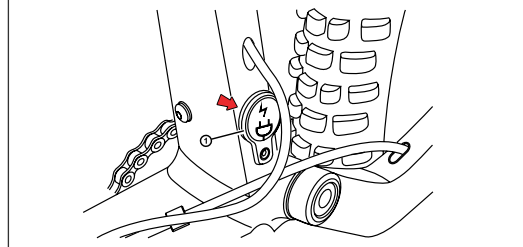

13.2 Die Ladebuchse (2) durch das Herausziehen der Gummikappe (1) öffnen.

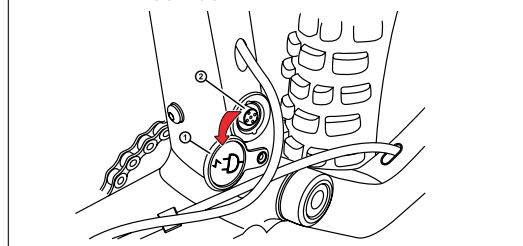

13.3 Ladegerät ans Stromnetz 220 V anschließen.

13.4 Verbindungsstecker des Ladegerätkabels (3) in der richtigen Stellung in die Ladebuchse (2) stecken.

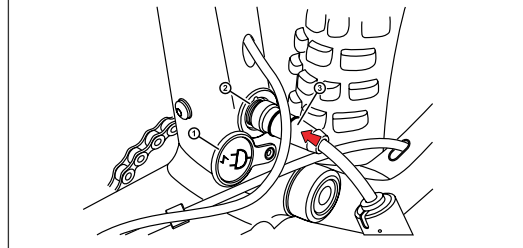

HINWEIS
Verbindungsstecker des Ladegerätkabel in die Buchse nicht eindrehen, es könnte zur Beschädigung der Kontakte kommen.

13.5 Nach dem Laden das Ladegerät vom Stromnetz 220 V trennen.

13.6 Verbindungsstecker des Ladegerätkabels (3) aus der Buchse ziehen.

13.7 Schließen Sie die Ladebuchse (2), indem Sie die Gummikappe (1) einsetzen.



HINWEIS AN DEN HÄNDLER
Senden Sie die beanspruchten Batterien immer in der Originalverpackung. Wir empfehlen daher, immer die Originalverpackung behalten.